

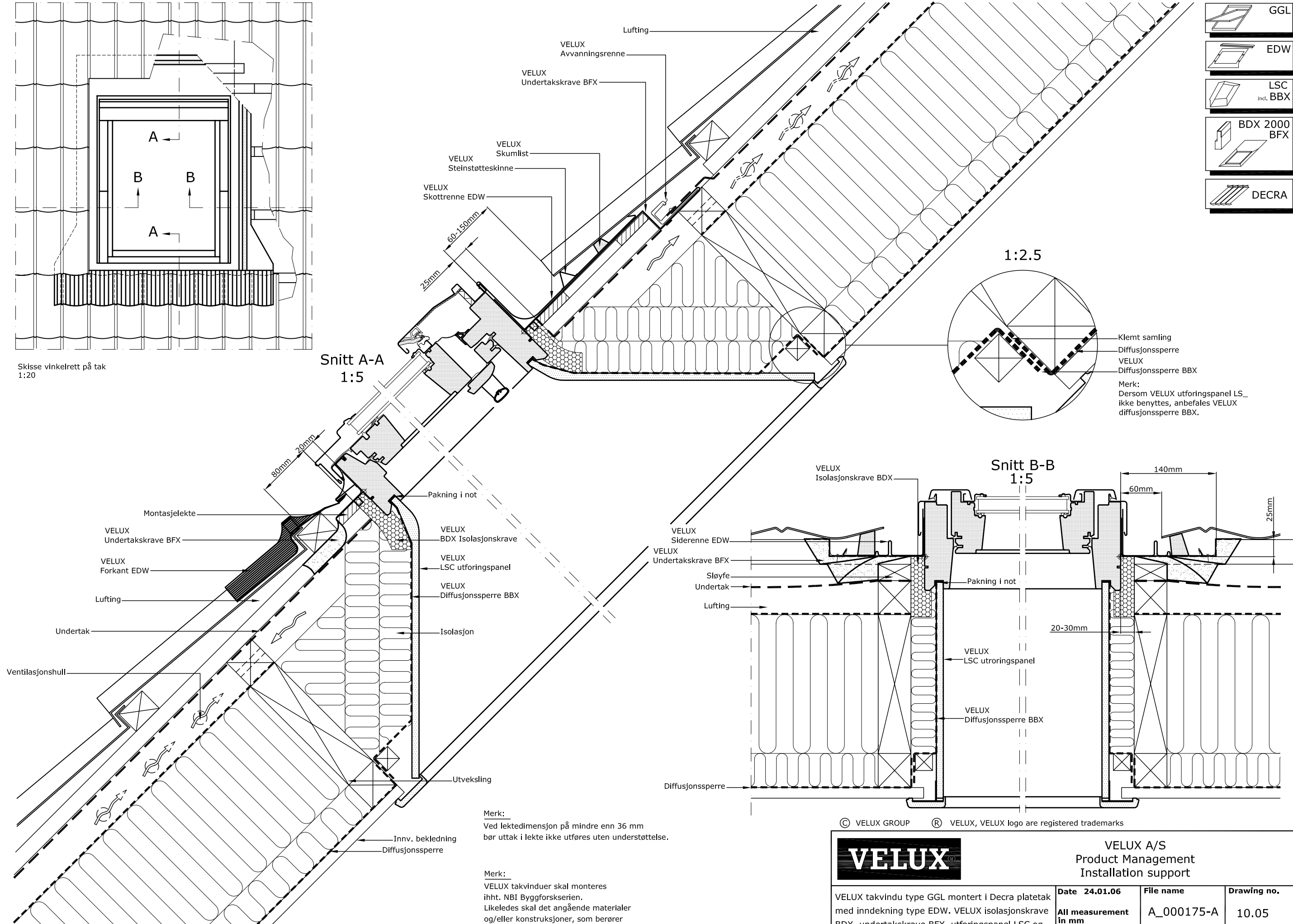



Skisse vinkelrett på tak  
1:20

Snitt A-A  
1:5

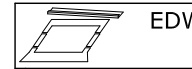
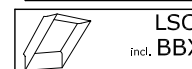

-  GGL
-  EDW
-  LSC  
incl. BBX
-  BDX 2000  
BFX
-  DECRA

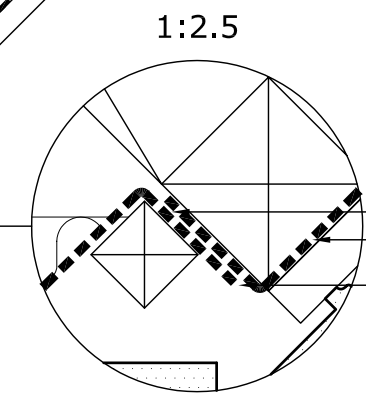

Klemt samling  
Diffusjonssperre  
VELUX  
Diffusjonssperre BBX  
Merk:  
Dersom VELUX utføringspanel LS\_ ikke benyttes, anbefales VELUX diffusjonssperre BBX.

Snitt B-B  
1:5

Merk:  
Ved lektedimensjon på mindre enn 36 mm bør uttak i lekte ikke utføres uten understøttelse.

Merk:  
VELUX takvinduer skal monteres ihht. NBI Byggforskerien. Likeledes skal det angående materialer og/eller konstruksjoner, som berører disse, henvises til produsentens anvisninger.

© VELUX GROUP ® VELUX, VELUX logo are registered trademarks



VELUX A/S  
Product Management  
Installation support

VELUX takvindu type GGL montert i Decra platetak med inndekning type EDW. VELUX isolasjonskrave BDX, undertakskrave BFX, utføringspanel LSC og diffusjonssperre BBX.

Date	File name	Drawing no.
24.01.06	A_000175-A	10.05
All measurement in mm		
SCo VELUX Norge AS		